

FLUQS-250 / 750 Wall Shelving System

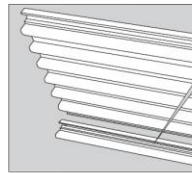

Installation Example

Ceiling Height (CH) : 2800 mm

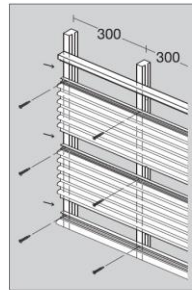
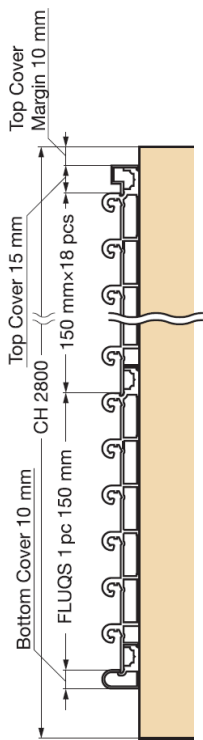

Install the bottom rail ①. Level the bottom rail before fastening. Insert the profile ② into the bottom rail. Fasten with screws.

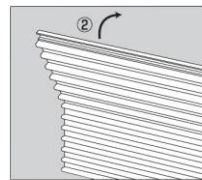

Install the profile ② until it reaches required height. The profile will cover the screws.

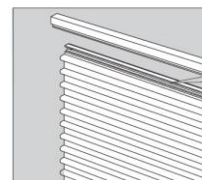

Snap-in the top rail to cover all the screws.

Corner Installation

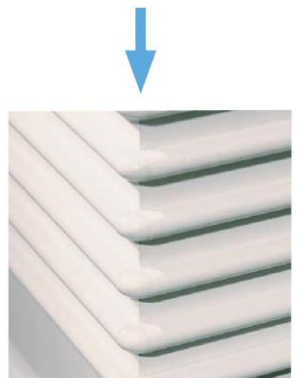
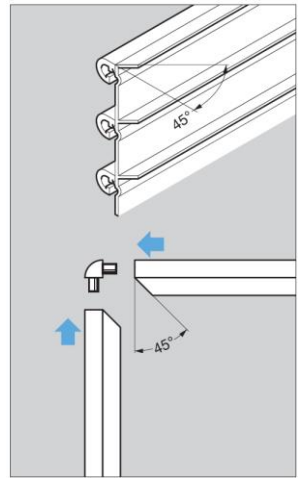

Corner Example

FLUQS 250/750 Part Details

No.	Part No.		Dimensions	Material/Finish	Length	Description
①	EX001-21	Main Panel FLUQS 250		Aluminium / Anodized	1820 mm	<ul style="list-style-type: none"> ● Basic Aluminium Wall Panel (Rail pitch 25 mm) ● Screw hole pitch 300 mm
②	EX004-21	Main Panel FLUQS 750		Aluminium / Anodized		<ul style="list-style-type: none"> ● Basic Aluminium Wall Panel (Rail pitch 75 mm) ● Screw hole pitch 300 mm
③	EX007-21	Top Cover		Aluminium / Anodized		<ul style="list-style-type: none"> ● Top Cover Track ● Covers the screw heads
④	EX008-21	Bottom Rail		Aluminium / Anodized		<ul style="list-style-type: none"> ● Bottom Track ● Screw hole pitch 300 mm
⑤	EX905-21	End Cap (1Way Type)		ABS / Matte Silver	—	—
⑥	EX906-21	End Cap (2Way Type)		ABS / Matte Silver	—	—
⑦	EX901-21	Corner Angle	 	Aluminium / Anodized	3000 mm	<ul style="list-style-type: none"> ● Corner plate to cover the edge of aluminium panel. ● Screws not included.

Accessories

Hook - For FLUQS-250/750/25/ONE Recess Mount

No.	Part No.		Dimensions	Material	Finish/Colour		Length	Load Capacity
①	EX030-20	Hook (φ3)		Steel	Chrome		15	1 kg
	EX031-20						30	
	EX032-20						55	
②	EX040-20	Hook (φ6)		Steel	Chrome		50	2 kg
	EX041-20						100	
	EX042-20						150	
③	EX046-20	Hook (φ9)		Steel	Chrome		100	3 kg
	EX047-20						150	
	EX048-20						200	

※ Can not be used with surface mount FLUQS-ONE

Shelf - For FLUQS-250/750/25/ONE

No.	Part No.		Dimensions	Material	Finish/Colour	W	D	t	Description		
①	EX201-41	Acrylic Shelf Set		Aluminium (Bracket)	Anodized (Bracket)	300	-	150	Load Capacity: 2.4 kg		
	EX202-41									200	
	EX203-41									250	
	EX206-41			Acrylic (Shelf)	Light Green (Shelf)	450	-	10		150	Load Capacity: 3.6 kg
	EX207-41									200	
	EX208-41									250	
	EX211-41			600	150	Load Capacity: 4.8 kg					
	EX212-41				200						
	EX213-41				250						
②	EX204-41	Adapter		Acrylic	-	300	-	-	For Shelf Holder when used with FLUQS ONE surface mount profile and bracket. (with double sided adhesive tape)		
	EX209-41									450	
	EX214-41									600	
③	EX026-21	Shelf Holder		Aluminium	Anodized	1820	10	9	*For 10 mm glass *Maximum shelf depth: 250 mm *For permanent installation, apply caulk to bracket and glass/acrylic *1 rubber strip (clear, 1820 mm) included *Glass not included, chamfer required as shown Load Capacity: 14.4 kg		
④	EX027-21	Shelf Holder		Aluminium	Anodized	1820	-	-	*For 10 mm glass *Maximum shelf depth: 450 mm *For permanent installation, apply caulk to bracket and glass/acrylic *1 clear rubber strip (1820 mm) included *Glass not included, chamfer required as shown Load Capacity: 30 kg		
⑤	EX090-21	Mini Hook		Aluminium	Anodized	10	-	-	Load Capacity: 3 kg		

FLUQS Wall Shelving System



FLUQS

Exto Series

FLUQS is a unique wall shelving system with an artistic touch and a contemporary look

The word FLUQS is from Latin "flatus" for wave, FLUQS frees you to arrange shelves in any pattern or configuration, how and when you please. The aluminium profile system is easy to install and adjust and visually coordinates well with gleaming aluminium, white or black finishes.

Easily blends into any atmosphere

- Fixing screws are invisible after installation
- Shelves available in acrylic and aluminium plate
- 2 types available: FLUQS 250/750 which can be used as wall panels and FLUQS 25/ONE which has single hook base match with any wall design

Designed for safety and flexibility

- Easy installation - simply screw in place (base required)
- Accessories such as hooks and shelves fit firmly and stay put